

SPECIFICATIONS FOR T7C SERIES

WHITE LED

Model: 7070

Part No: T7C***G1R-*****

Features:

- * Top view white LED
- * Thermally Enhanced Package Design
- * High luminous flux output
- * High current capability
- * Compact Package Size
- * Wide viewing angle
- * Pb-free Reflow Soldering Application
- * The product itself will remain within RoHS compliant version



Applications

- * Architectural / Decorative lighting
- * Retrofits (replacement)
- * General lighting
- * Indoor & Outdoor sign board back light

Part Numbering System

T □□ □□ □ □ □ □ - □ □□ □□ □
 X1 X2 X3 X4 X5 X6 X7 X8 X9 X10

Item Number Code	Description	Content
X1	Type code	1S:1010; 1A:1919; 20:2016; 3B:3014; 28:2835 34:3020; 3C:3030; 5C:5050; 7C:7070; 1D:100100; 19: Ceramic 3535; 15: Ceramic 5050; 11: Ceramic 1616.
X2	CCT code	2700K:27; 3000K:30; 4000K:40; 5000K:50; 5700K:57; 6500K:65; RE:Red;GR:Green;BL:Blue;YE:Yellow; PA:PC Amver;IR: Infrared;
X3	Color Rendering	Ra70:7; Ra80:8; Ra90:9.
X4	No. of serial chip	1-Z.
X5	No. of parallel chip	1-Z.
X6	Component code	A-Z.
X7	Color Code	M:ANSI; F:ERP; R:85℃ ANSI; T:105℃ ANSI; B:Backlighting; Q:Others;
X8	Internal code1	\
X9	Internal code2	\
X10	Spare code	\

Electro Optical Characteristics, IF = 180mA, Tj = 25°C

CCT	Color Rendering	Luminous Flux	
	Min	Typ	Min
2700K	70	1310	1200
	80	1250	1100
	90	1050	950
3000K	70	1370	1200
	80	1300	1200
	90	1090	1000
4000K	70	1430	1300
	80	1360	1200
	90	1160	1000
5000K	70	1430	1300
	80	1360	1200
	90	1160	1000
5700K	70	1430	1300
	80	1360	1200
	90	1160	1000
6500K	70	1430	1300
	80	1360	1200
	90	1160	1000

* Tolerance of measurements of the Luminous Flux is $\pm 7\%$.

* Ra measurement tolerance is ± 2 .

Absolute Maximum Ratings at Tj=25°C

Item	Symbol	Absolute Maximum Rating	Unit
Forward current	IF	200	mA
Pulse Forward current	IFP	300	mA
Power Dissipation	PD	10400	mW
Reverse Voltage	VR	5	V
Operating Temperature	Topr	-40~+105	°C
Storage Temperature	Tstg	-40~+85	°C
Junction Temperature	Tj	120	°C
Soldering Temperature	Tsld	Reflow Soldering: 230°C or 260°C for 10sec	

* I_{FP} condition with Pulse: Width≤100μs, Duty cycle≤1/10.

* LED's properties might be different from suggested values like above and below tables if operation condition will be exceeded our parameter range. Care is to be taken that power dissipation does not exceed the absolute maximum rating of the product.

* All measurements were made under the standardized environment of Lightning LED.

Electrical/Optical Characteristics at Tj=25°C

Item	Symbol	Min	Typ	Max	Unit	Condition
Forward Voltage	VF	46	49	52	V	IF=180mA
Reverse Current	IR	-	-	10	μA	VR=5V
View Angle	2θ _{1/2}	-	120	-	°	IF=180mA
Thermal resistance	(R _{th j-sp})	-	1.5	-	°C/W	IF=180mA
Electrostatic Discharge	ESD	1000	-	-	V	HBM

* Tolerance of measurements of the Forward Voltage is ±3%.

* 2θ_{1/2} is the off-axis where the luminous intensity is 1/2 of the peak intensity.

* R_{th j-sp} is the thermal resistance from LED junction to solder point on MCPCB with electrical power.

Bin Structure

Luminous Flux Ranks, IF = 180mA, Tj =25°C

CCT	Color Rendering		Luminous Flux		
	Min.	Typ.	Code	Min	Max
2700K	70	72	3C	1200	1300
			3D	1300	1400
			3E	1400	1500
			3F	1500	1600
	80	82	3B	1100	1200
			3C	1200	1300
			3D	1300	1400
			3E	1400	1500
	90	92	GX	950	1000
			3A	1000	1100
			3B	1100	1200
			3C	1200	1300
3000K	70	72	3C	1200	1300
			3D	1300	1400
			3E	1400	1500
			3F	1500	1600
	80	82	3C	1200	1300
			3D	1300	1400
			3E	1400	1500
			3F	1500	1600
	90	92	3B	1100	1200
			3C	1200	1300
			3D	1300	1400
			3E	1400	1500
4000K/5000K/ 5700K/6500K	70	72	3D	1300	1400
			3E	1400	1500
			3F	1500	1600
			3G	1600	1700
	80	82	3C	1200	1300
			3D	1300	1400
			3E	1400	1500
			3F	1500	1600
	90	92	3A	1000	1100
			3B	1100	1200
			3C	1200	1300
			3D	1300	1400

* Tolerance of measurements of the Luminous Flux is $\pm 7\%$.

* Ra measurement tolerance is ± 2 .

Forward Voltage Ranks, $I_F = 180\text{mA}$, $T_j = 25^\circ\text{C}$

Code	Min	Max	Unit
6R	46	48	V
6S	48	50	V
6T	50	52	V

* Tolerance of measurements of the Forward Voltage is $\pm 3\%$.

CIE Chromaticity Diagram, $I_F = 180\text{mA}$, $T_j = 25^\circ\text{C}$

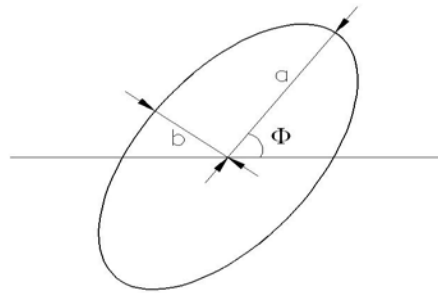

The color ranks have chromaticity ranges within 5-step MacAdam ellipse

Color Code	Center		Radius		Angle(deg)
	x	y	a	b	Φ
27R5	0.4620	0.4145	0.013500	0.007000	53.42
30R5	0.4383	0.4081	0.013900	0.006800	53.12
40R5	0.3875	0.3868	0.015650	0.006700	53.43
50R5	0.3507	0.3635	0.013700	0.005900	59.37
57R5	0.3348	0.3491	0.011175	0.005500	58.35
65R5	0.3187	0.3363	0.011150	0.004750	58.34

* Energy Star binning applied to all 2600~7000K.

* Tolerance of measurements of the chromaticity Coordinate is ± 0.005 .

Fig 1. Color Spectrum, $T_j = 25^\circ\text{C}$ $R_a \geq 70$

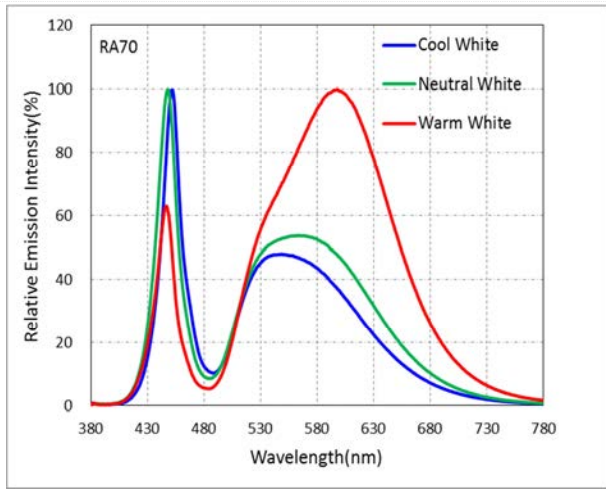

Fig 3. Color Spectrum, $T_j = 25^\circ\text{C}$ $R_a \geq 90$

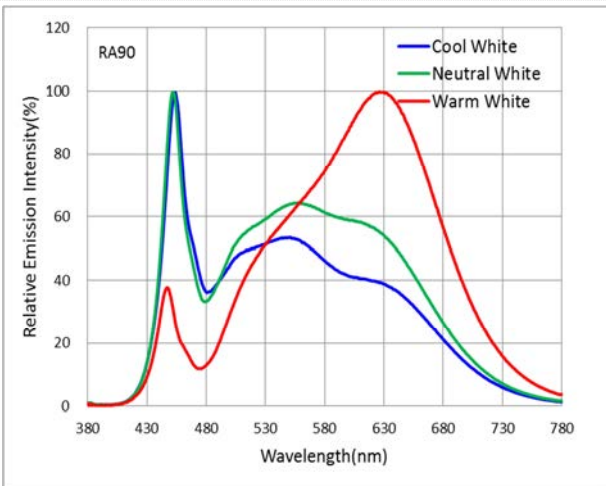

Fig 5. IF vs. Relative Luminous flux.

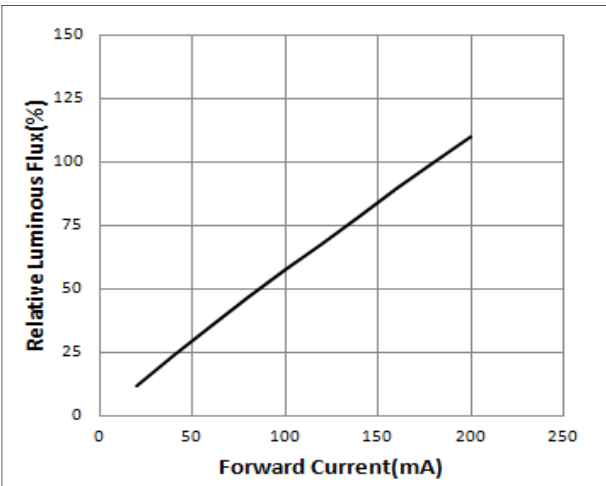

Fig 2. Color Spectrum, $T_j = 25^\circ\text{C}$ $R_a \geq 80$

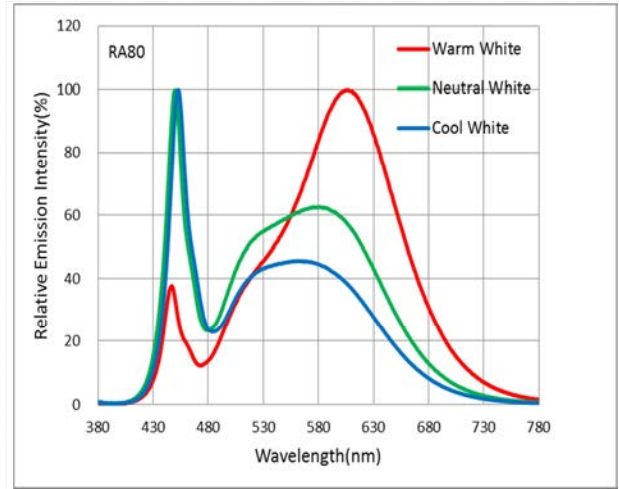

Fig 4. Viewing Angle Distribution, $T_j = 25^\circ\text{C}$

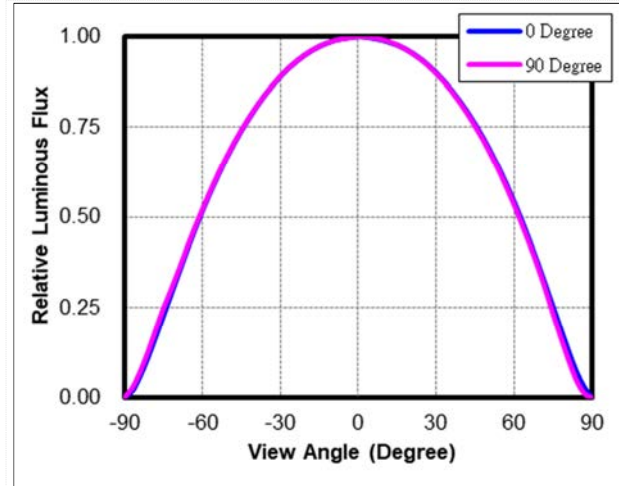

Fig 6. Forward Voltage vs. Forward Current

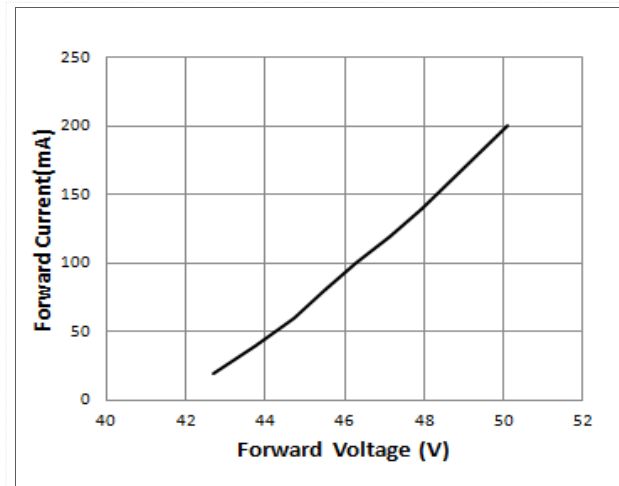

Fig 7.Ts—Relative Luminous flux.

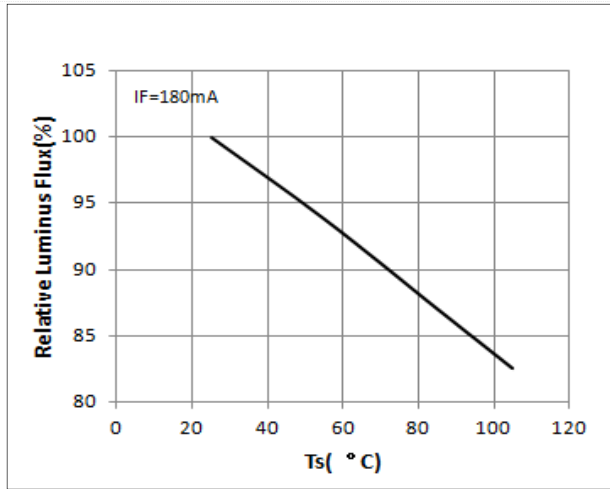

Fig 9. Ts vs. CIE x, y Shift

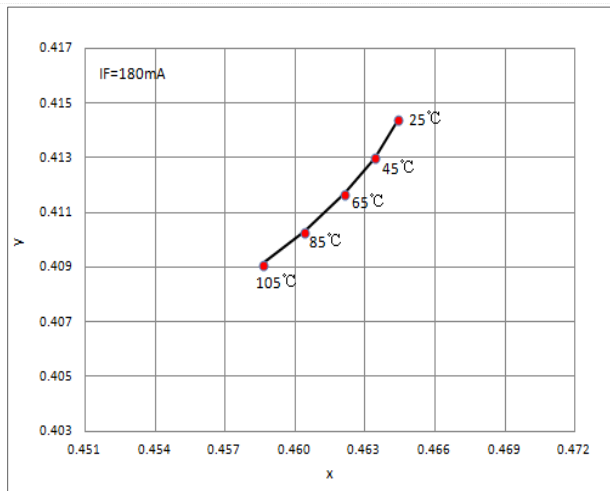

Fig 8.Ts—Forward Voltage

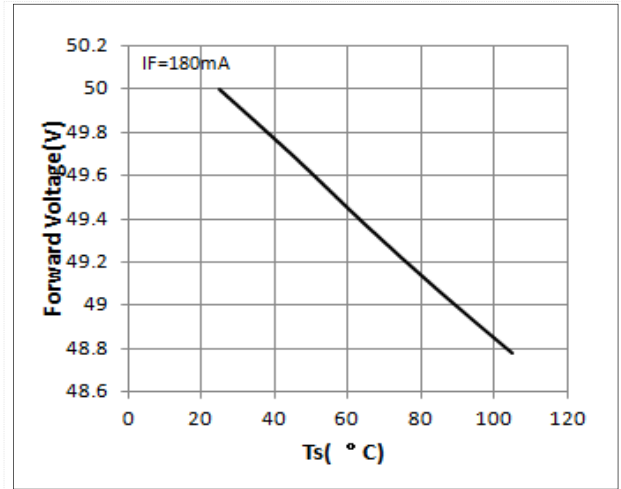
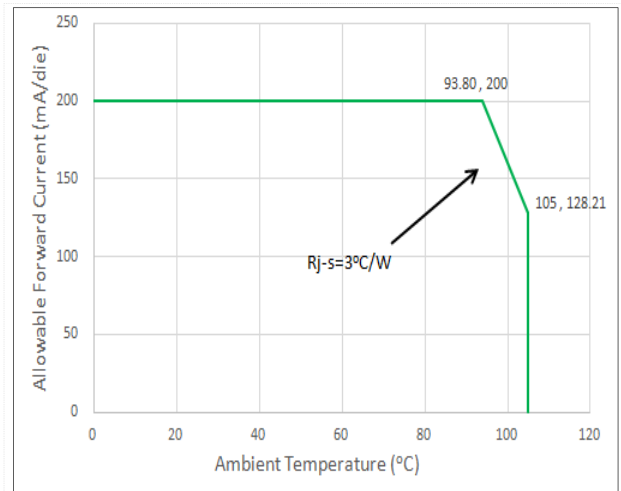
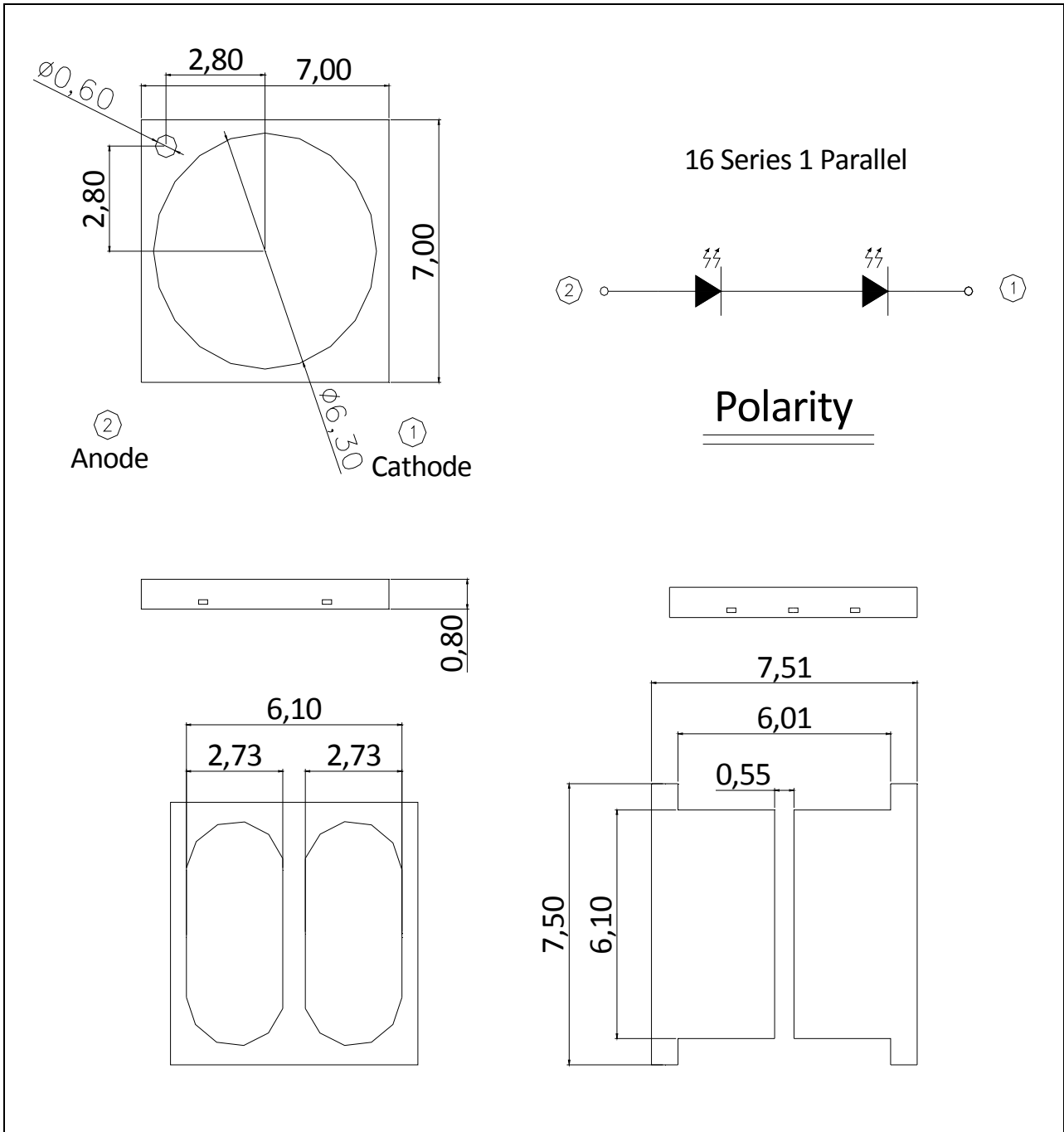

Fig 10 .Maximum Forward Current vs. Ambient Temperature



Package Dimensions



* The tolerance unless mentioned is ± 0.1 mm, unit = mm

Reflow Soldering Characteristics

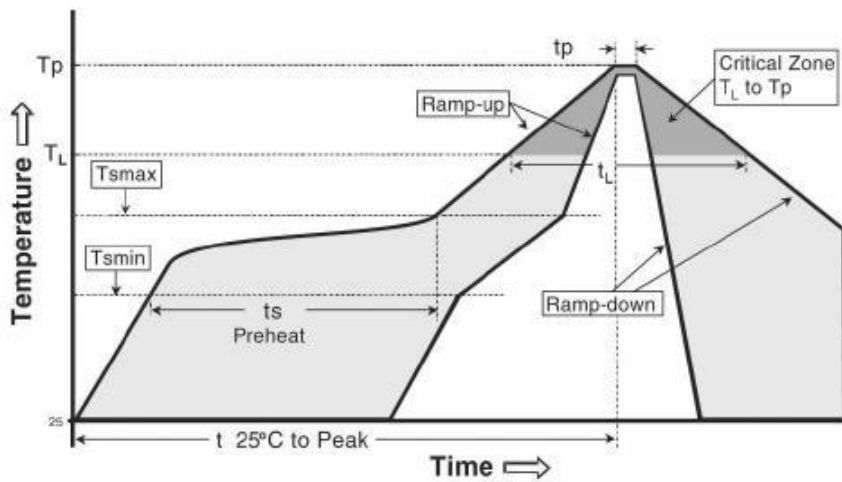

Reflow soldering	
Temperature Min (Tsmin)	150° C
Temperature Max (Tsmax)	200° C
Time(ts)from (Tsmin to Tsmax)	60-120 seconds.
Ramp-up rate (TL to Tp)	3° C/seconds max.
Liquidous temperature(TL)	217° C
Time(tL) maintained above TL	60-150 seconds
Peak package body temperature(Tp)	260° C max
Time (tp) within 5° C of the specified classification temperature (Tc).	30 seconds max
Ramp-down rate (Tp to TL)	6° C/second max
Time 25° C to peak temperature	8 min max

Package Dimensions of Tape

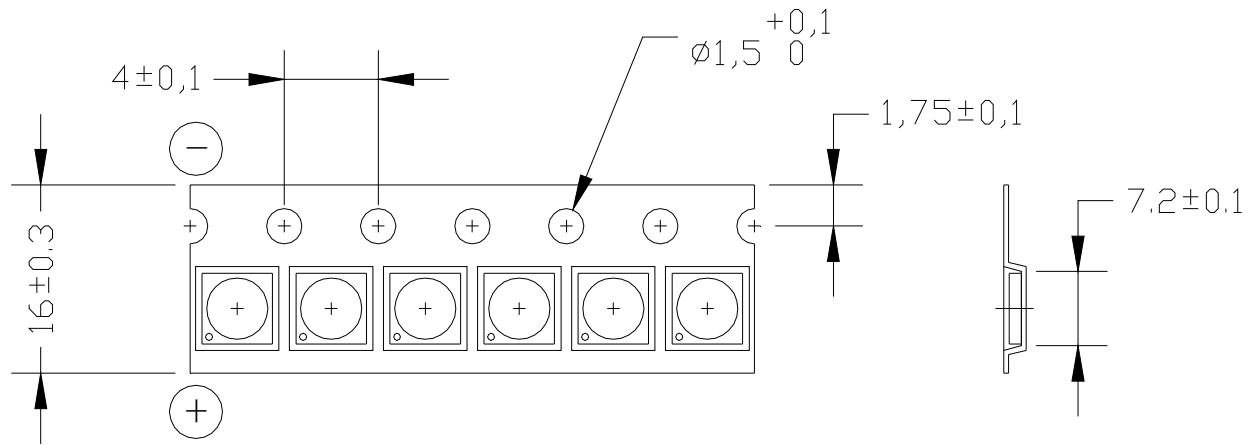

- * Quantity : Max 1000pcs/Reel
- * Cumulative Tolerance : Cumulative Tolerance/10 pitches to be $\pm 0.2\text{mm}$
- * Package : P/N, Manufacturing data Code No. and Quantity to be indicated on a damp proof Package.
- * Adhesion Strength of Cover Tape Adhesion strength to be 0.1-0.7N when the cover tape is turned off from the carrier tape at the angle of 10° to the carrier tape

Package Dimensions of Reel

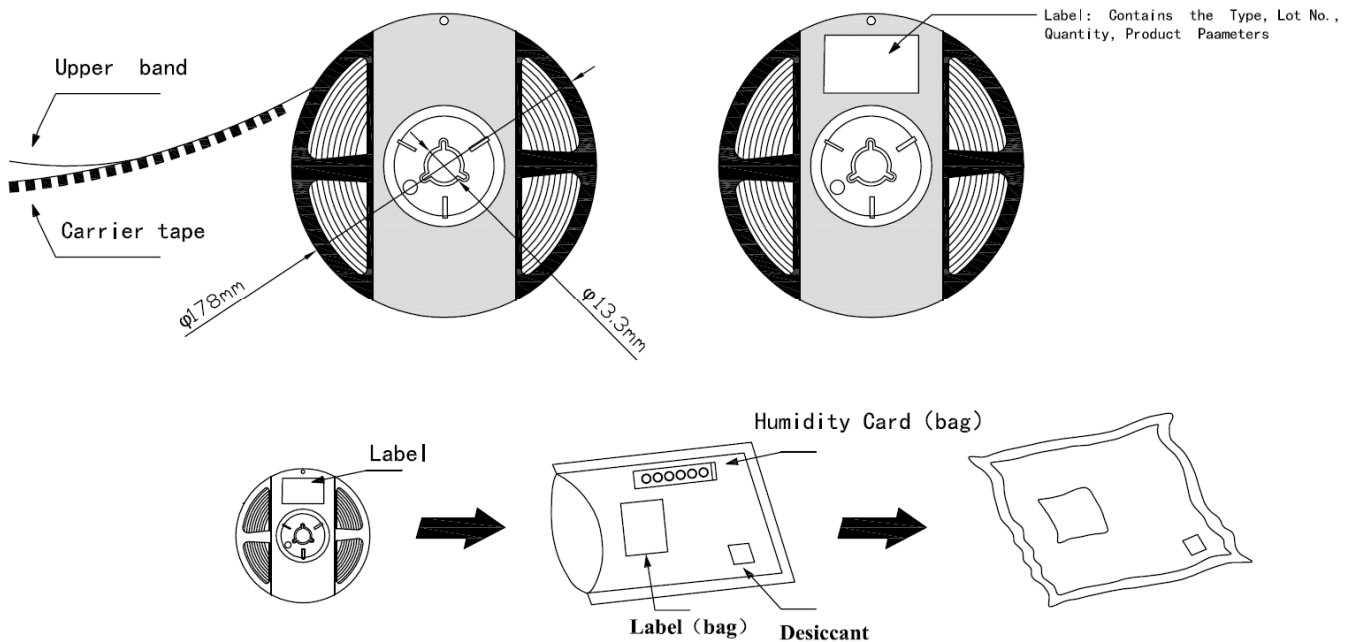

Package Box

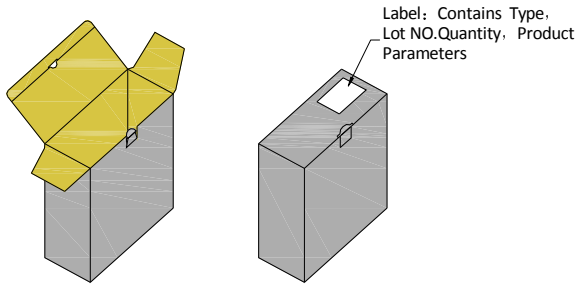

* Capacity 4 or 8 reels per box.

Outer Box

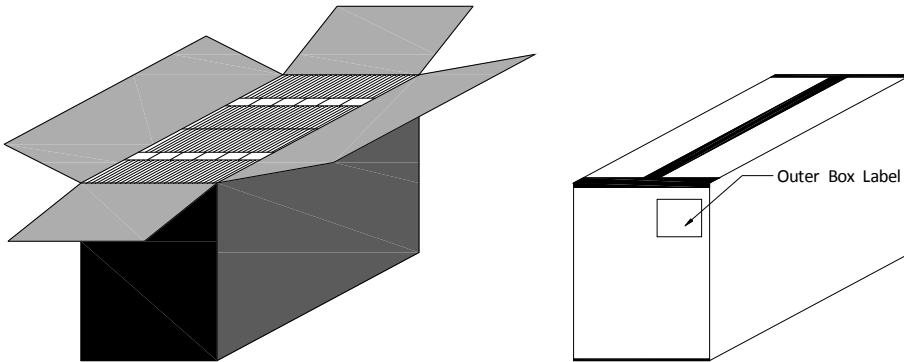

* Capacity 24 or 48 reels per box.

Label :

福建天电光电有限公司
FUJIAN LIGHTNING OPTOELECTRONIC CO.LTD

型号Type:T*****_*****



光通量Φ@ *** mA: *** - *** [LM]

色区Color Bin@*** mA: ****

电压Vf@ ***mA: ** - ** [V]

显指Ra@ *** mA: ** (MIN)

Lot No.:A*****_.*_*****

Bin Code: **** 数量QTY:**** PCS



Caution

1. Reflow soldering is recommended not to be done more than two times. In the case of more than 24 hours passed soldering after first, LEDs will be damaged.
2. Repairs should not be done after the LEDs have been soldered. When repair is unavoidable, suitable tools must be used.
3. Die slug is to be soldered.
4. When soldering, do not put stress on the LEDs during heating.
5. After soldering, do not warp the circuit board.

Notes on Lightning EMC Series soldering:

1. Recommend to use reflow machine.
2. Recommend to use heating plate soldering.
3. Manual soldering is not recommended.

Notes on reflow process:

1. To confirm whether the actual temperature curve in the reflow soldering conditions comply with recommended conditions. LEDs are guaranteed for one time reflow.
2. During reflow process do not apply force on LED active area.
3. After reflow process, PCB board should be cooled down before packing or storage.

Precaution for use

Storage

1. Before opening the package: The LED should be kept at $5^{\circ}\text{C}\sim 30^{\circ}\text{C}$ and 60%RH or less.
2. After opening the package: The LED's floor life is 168Hrs under 30°C or less and 60%RH or less. If unused LED remain, it should be stored in moisture proof packages JEDEC (MSL 3).
3. If the moisture absorbent material (silica gel) has faded away or the LEDs have exceeded the storage time, baking treatment should be performed using the following conditions:
Baking treatment: $60\pm 5^{\circ}\text{C}$ for 24 hours.