

EMC 系列 LED 散热管理设计指引

Thermal Management of EMC LED Lamp

简介

本LED光源散热指引旨在详细说明天电光电EMC系列LED产品(T20 Series-2016, T3B Series-3014, T34 Series-3020, as well as T3C Series-3030)在不同温度下的性能表现, 客户在使用EMC LED过程中必须要注意可能遇到的热学问题, 相关指引可以引导客户正确使用产品, 发挥EMC LED产品的最大效能。

Description

This application note describes the types of failures common to middle to high-power LEDs, details TDLED's pre-release qualification testing for EMC Series LEDs (T20 Series-2016, T3B Series-3014, T34 Series-3020, as well as T3C Series-3030) including the results of white point stability testing. Through clearly understanding of EMC LED characteristics at different ambient temperature, customers or users could better use the LED lamp thus achieve the best overall performance of the light fixture thereof.

Prepared by: AE Department Date: 2014-5-28

Checked by: Date:

Approved by: Date:

Revision History

Version	Page	Content of Change	Date
1.0	1-11	Preliminary Document (Technical Article on Thermal Management)	2014/5/28
1.1	5-6	Added Figure 4, 5, 6	2014/6/16

● Introduction

While designing a light fixture using LEDs, it is important to effectively dissipate the heat generated by the LEDs. As known to us all, the majority of LED failure mechanisms are temperature-dependent. Elevated P/N junction temperatures cause light output reduction and accelerated chip degradation. Junction temperature is primarily affected by three parameters: 1. ambient temperature of the LED's immediate surroundings; 2. thermal path between the LED junction and ambient conditions; 3. power dissipated by the LED. (The maximum junction temperature for each product line is specified in the product data sheet.) Thus, it is important to have a good thermal design to keep the junction temperature as low as possible. This application note would contain the information on thermal management background as well as how to make a good thermal design thereof.

● Heat path for LED package

Figure 1 shows an example of how the heat passes through the LED package. It is seen that the heat is transmitted to the air by going through the die bond, electrodes, solder, and the board underneath.

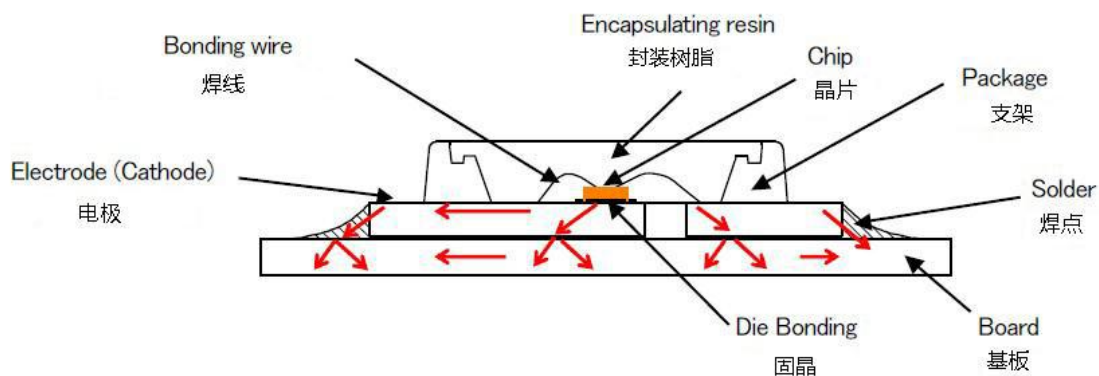

Figure 1 An example of LED's structure and heat path

The thermal resistance between two points is defined as the ratio of the difference in temperature to the power dissipated. In the case of LEDs, the resistance of two important thermal paths affects the junction temperature:

- From the LED junction to the thermal contact at the bottom of the package. This thermal resistance is governed by the package design. It is referred to as the thermal resistance between junction and solder point ($R_{th\ j-s}$)
- From the thermal contact to ambient conditions. This thermal resistance is defined by the path between the solder point and ambient. It is referred to as the thermal resistance between solder point and ambient ($R_{th\ s-a}$)

The overall thermal resistance between the LED junction and ambient ($R_{th\ j-a}$) can be modeled as the sum of the series resistances $R_{th\ j-s}$ and $R_{th\ s-a}$.

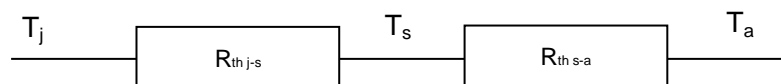

Figure 2 Calculation model of thermal resistance from junction to ambient

In most cases, power LEDs will be mounted on metal-core printed circuit boards (MCPCB), which will be attached to a heat sink. Heat flows from the LED junction through the MCPCB to the heat sink by way of conduction. The heat sink diffuses heat to the ambient surroundings by convection. In most LED applications, the contact thermal resistance between LED and MCPCB and/or heat sink is small with respect to the thermal resistance between the junction and thermal pad and thermal pad to ambient.

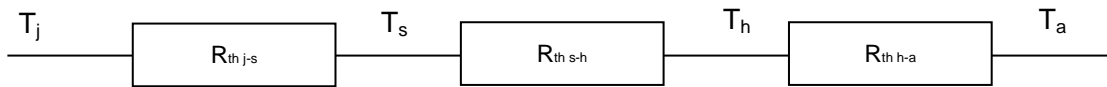

Figure 3 Calculation model of thermal resistance from junction to ambient (including a heat sink)

When a heat sink is used, the total thermal resistance is the series resistances from the junction to the solder point ($R_{th\ j-s}$), from the solder point to the heat sink ($R_{th\ s-h}$) and from the heat sink to ambient ($R_{th\ h-a}$).

$$R_{th\ j-a} = R_{th\ j-s} + R_{th\ s-h} + R_{th\ h-a}$$

The temperature of the LED junction (T_j) is the sum of the ambient temperature (T_a) and the product of the thermal resistance from junction to ambient and the power dissipated.

$$T_j = T_a + (R_{th\ j-a} \times P_d)$$

$$P_d = V_f \times I_f$$

(V_f is the forward voltage and I_f is the forward current of the LED.)

Note that the direct heat loss from the LED package to ambient is small enough to be neglected for calculations. The overall design goal in determining the size and nature of the required heat sink is to calculate the maximum heat sink thermal resistance ($R_{th\ h-a}$) that will maintain the junction temperature below the maximum value at worst-case operation conditions. Suppose an acceptable maximum junction temperature of the LED as well as the interface condition^{***} between solder point and the heat sink, we may conclude a up limit of the heat sink suitable for this particular LED.

^{***}The thermal resistance between the LED solder-point and heat sink, $R_{th\ sp-h}$, depends on the surface finish, flatness, applied mounting pressure, contact area, and the type of interface material and its thickness. With good design, it can be minimized to less than 1°C/W. A heat sink with the required characteristics may be selected using figures published by heat sink manufacturers or through modeling and testing.)

Example of EMC2016: Test and Calculate Thermal Resistance

TDLED does not recommend operating EMC LEDs without a heat sink. This example demonstrates the procedure for calculating the thermal resistance and maximum operating temperature of one EMC2016 on a 1-inch² MCPCB.

Since there is no additional heat sink in this example, the MCPCB serves as the heat sink and thermal interface to ambient. In order to calculate the thermal resistance from junction to ambient, the temperature on the back of the LED must be measured. In this case, the LED is reflow soldered on MCPCB. The board temperature can be measured by applying a thermocouple directly to the back of the MCPCB. In most applications, it is impossible to

福建天电光电有限公司
FUJIAN LIGHTNING OPTOELECTRONIC CO., LTD.

attach a thermocouple to the solder point of the LED. The test point should be the point that is as close as possible to the back of the LED or the hottest point on the back of the MCPCB. See Figure 4 for the recommended measurement setup.

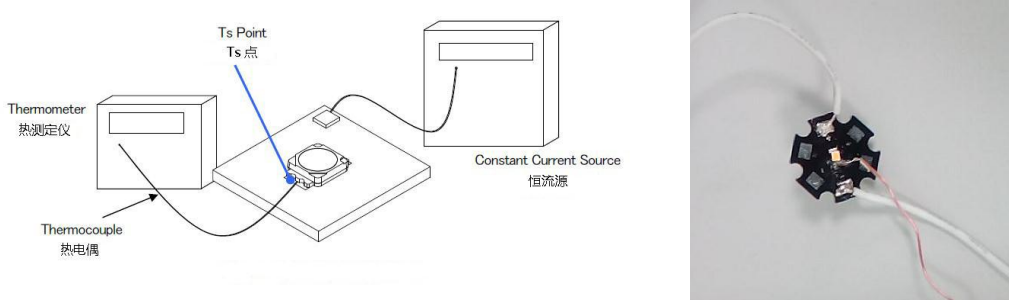

Figure 4 Thermal testing set up for the LED and the real sample (EMC2016 on MCPCB) test

Figure 5 shows the MCPCB temperature at different forward currents. The room temperature was around 30.3°C. Due to the low thermal conductance of the MCPCB to air, temperatures quickly reach a steady-state.

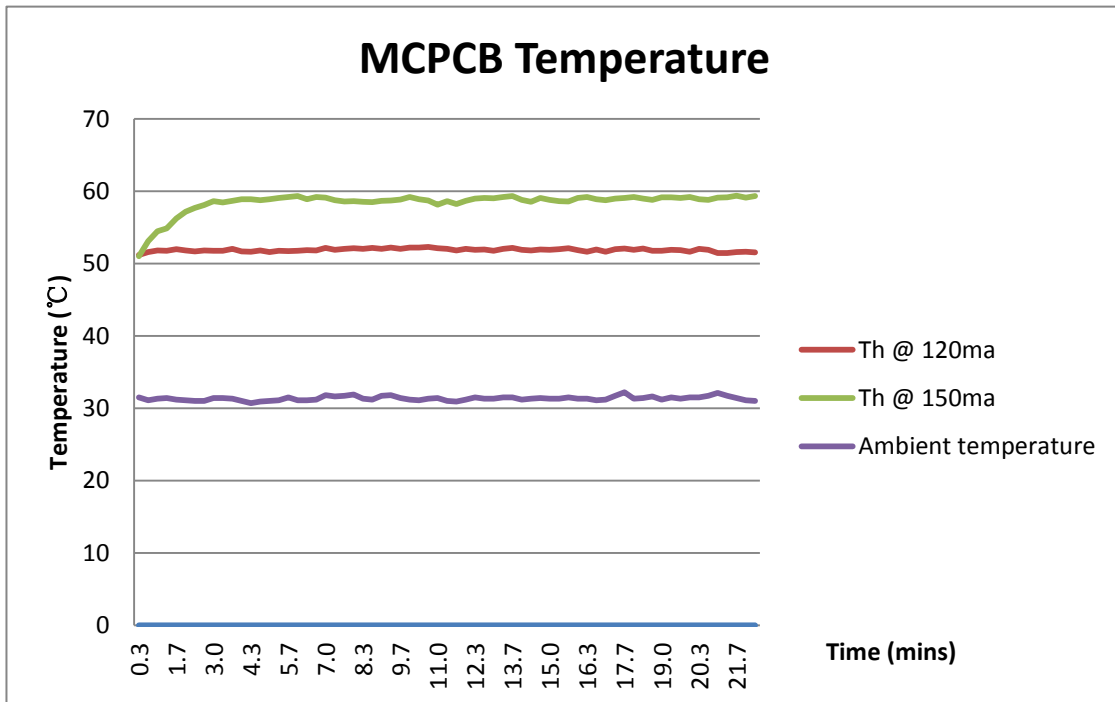

Figure 5 MCPCB temperature comparisons

The MCPCB temperature (T_h) can be measured at different forward currents. The junction temperature at different currents can be calculated by:

$$T_j = T_a + P_{total} \times R_{th-j-a}$$

Where,

$$R_{th\ j-a} = R_{th\ j-h} + R_{th\ h-a}$$

$$R_{th\ j-h} = R_{th\ j-s} + R_{th\ s-h} \text{ (normally } 1^{\circ}\text{C/W for high-end MCPCB)}$$

$$R_{th\ h-a} = (T_h - T_a) / P_{total}$$

$$P_{total} = I_f \times V_f; T_a = 31.3^{\circ}\text{C}$$

Figure 6 shows the test result example of $R_{th\ j-s}$ (at 150mA) using T3Ster Master for this calculation.

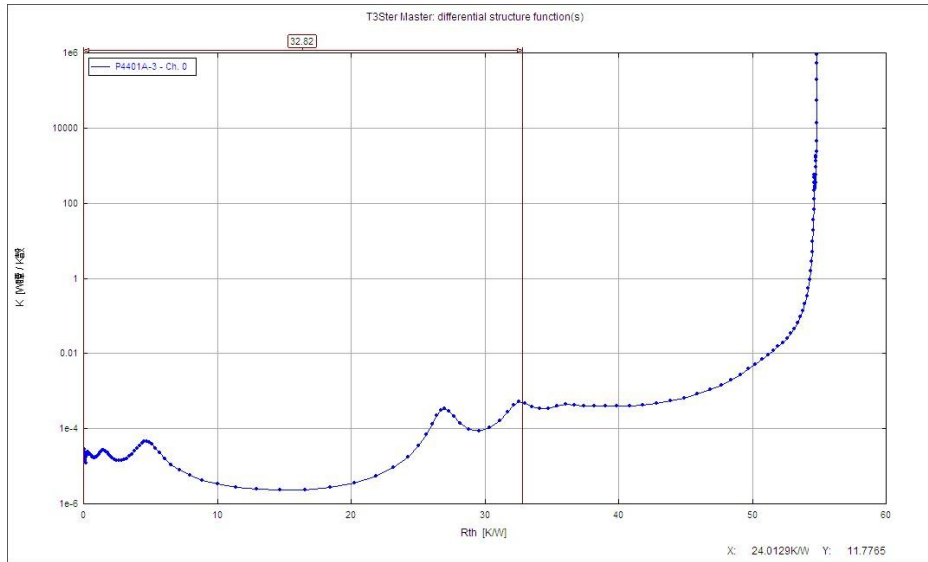

Figure 6 R_{th} measurement results using T3Ster Master

Table 1 summarizes the calculation results at different current driving. The junction temperature is well controlled below the maximum junction temperature in the specific datasheet.

Table 1 Junction temperature calculation of EMC2016

I_f (mA)	V_f (V)	P_d (W)	T_h ($^{\circ}\text{C}$)	$R_{th\ h-a}$ ($^{\circ}\text{C/W}$)	$R_{th\ j-h}$ ($^{\circ}\text{C/W}$)	T_j ($^{\circ}\text{C}$)
120	3.3	0.396	51.5	50.9	30.3	63.5
150	3.4	0.51	59.3	54.8	33.8	76.5

● Thermal Design Guide

When designing lighting systems using high-power LEDs, the following general guidelines should be followed:

- The most important consideration for successful thermal design is to minimize the amount of heat that needs to be removed. It is important to separate the LED drive circuitry from the LED board so that the heat generated by the driver will not contribute to the LED junction temperature.
- The next most effective strategy is to minimize the ambient temperature inside the fixture. This goal is achieved by paying attention to several design parameters such as a conservative packaging design that does not allow the upper limit on overall system power density to be reached. Maintaining clear and clean airflow paths for natural convection cooling is vital as well.
- Enhancing thermal conductivity between the heat sinks and the LED is very preferable for thermal

福建天电光电有限公司
FUJIAN LIGHTNING OPTOELECTRONIC CO., LTD.

management. Even though the heat removal from the heat sink is via convection, the path from the LED to the heat sink depends upon conduction.

- Finally, the orientation of the LED PCB/heat sink should be considered carefully. It is important to position the board/heat sink so that the plane is vertical. If the board plane is horizontal, it will block the formation of air convection currents and substantially reduce the cooling capability of the system.

In order to design a good thermal management, there listed below keys:

1. Choice of PCB materials;
2. Optimization of the copper foils area of the PCB;
3. Optimization of the LED placement (LED pitch);
4. Implementation of heat sinks;

Details are explained as follows:

1. Choice of PCB materials

Printed circuit board (PCB) can be classified as resin, metal-based, or ceramic as shown in Figure 7.

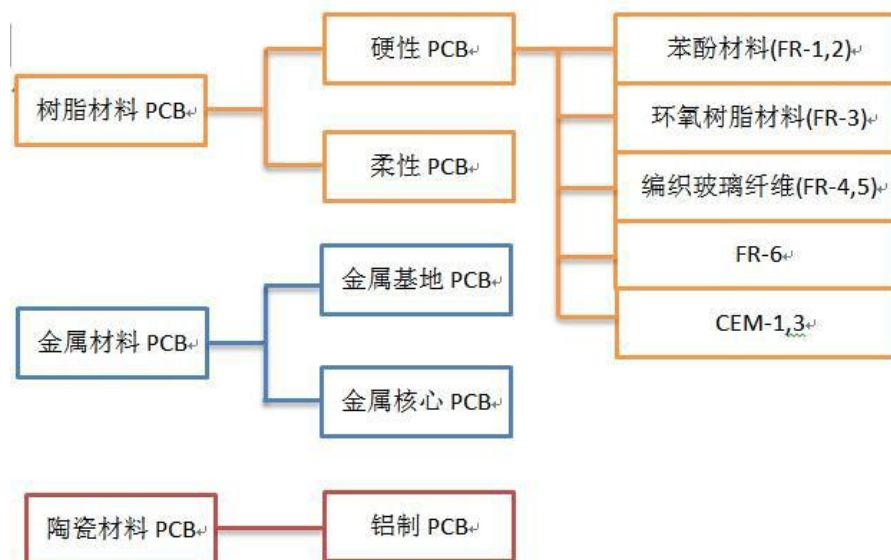

Figure 7 Classification of PCB

FR-4 boards are commonly used due to its cost and dimension consistency. However, by using a metal-based PCB, higher thermal conductivity can be achieved and will benefit for lowering the T_j of the LED. As a reference, Table 2 and Figure 8 show the thermal measurement results comparison of FR-4 and MCPCB.

Assuming that the board sizes are the same, it is clearly seen that the T_j is lower on the aluminum board compared to FR-4 board.

	Type A	Type B	Type C	Type D
Main Material	FR-4			Aluminum
Rthj-a [°C/W]	63	50	44	34
PWB Size	30mm × 30mm, t=1.6mm			30mm × 30mm, t=1.7mm
Copper Area Face	154mm ² , t=0.07mm	302mm ² , t=0.07mm	616mm ² , t=0.07mm	500mm ² , t=0.07mm
Copper Area Back	154mm ² , t=0.07mm	302mm ² , t=0.07mm	616mm ² , t=0.07mm	-
I _F (mA)	700			
V _F (V)	3.18	3.24	3.29	3.30
T _s (°C)	143	118	95	80
T _j (°C)	165	141	118	103

※Measurement condition : Rthj-s = 10°C/W, Ta=25°C, Thermo Couple: Φ0.076mm

Table 2 Thermal measurement results comparison

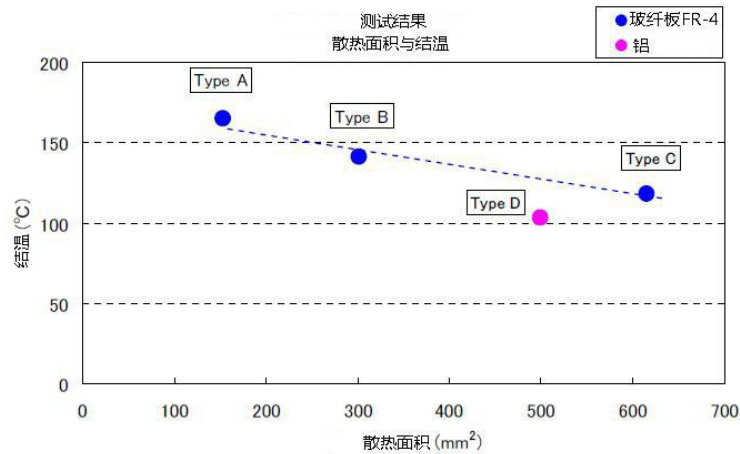

Figure 8 Thermal measurement results comparison

2. Optimization of the copper foils area of the board

To transfer the heat generated by the chip to the board as much as possible, it is recommended to increase the thermal conductive area by increasing the area of the copper foils as shown in Figure 9. (Results refer to Table 2)

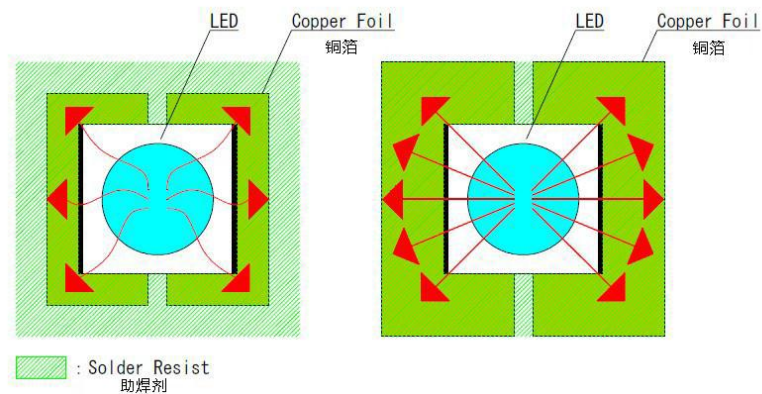

Figure 9 Copper foils pattern of the PCB

3. Optimization of the LED placement (LED pitch)

If the LED pitch becomes too narrow as shown in Figure 10, it becomes harder to radiate the heat generated in the center area of the board. From the simulated results (Figure 11), it can be seen that the heat is trapped when the LED pitch is narrow; by increasing the LED pitch as much as possible, T_j can be lowered. Since the simulation is set to have the copper foils area as large as possible to have the widest pitch, the copper foils area will be different for each simulation.

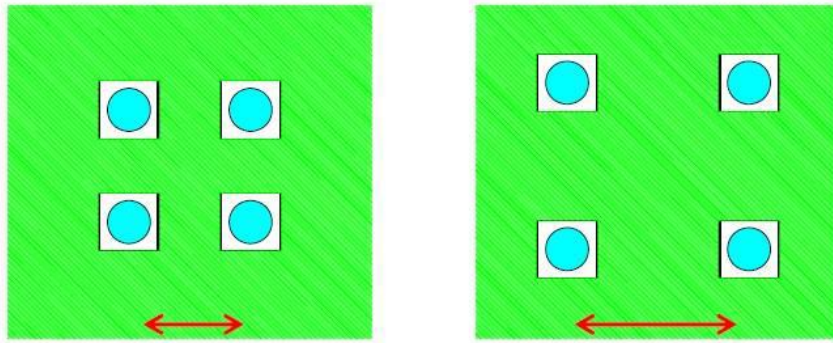

Figure 10 LED placements at different pitch

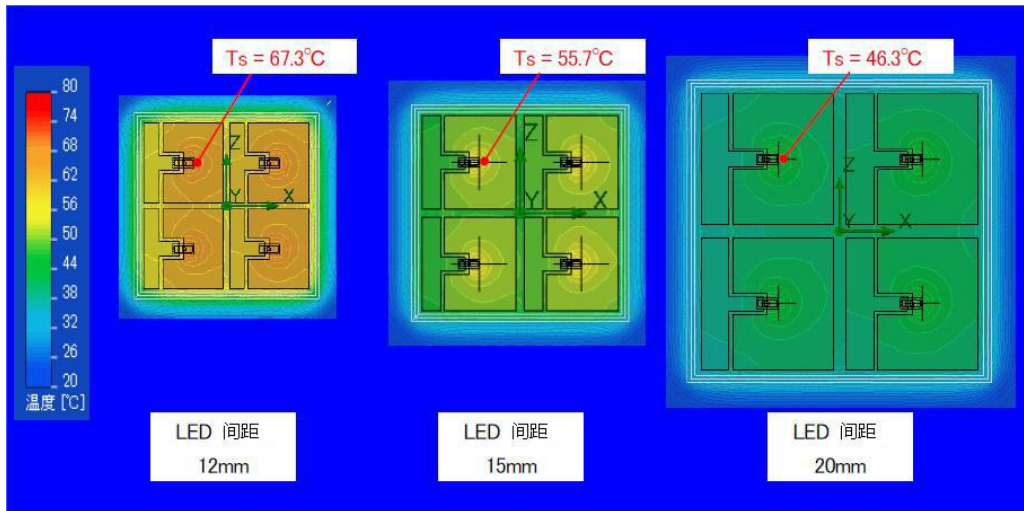

Figure 11 Simulation results on thermal distribution (3014)

4. Implementation of heat sinks

The heat dissipation efficiency can be improved by attaching a heat sink to the back side of the PCB. Table 3 shows the measurement results with or without a heat sink. It can be seen that both $R_{th\ j-a}$ and T_j are lower when a heat sink is attached. To further improve, it is recommended to attach heat sink to board using a thermally conductive tape, sheet, or grease to lower the interface thermal resistance. Examples of connecting a heat sink to the board are

shown in Figure 12.

Table 3 Thermal measurement results with and without the heat sink

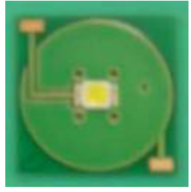
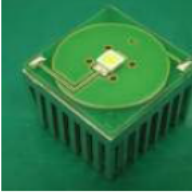
		
	without Heat Sink	with Heat Sink
Main Material	FR-4	
Rthj-a [°C/W]	44	32
PWB Size	30mm × 30mm, t=1.6mm	
Copper Area	616mm ² , t=0.07mm	
I _F (mA)	700	
V _F (V)	3.29	3.49
T _s (°C)	95	73
T _j (°C)	118	97

※Measurement condition : Rthj-s=10°C/W, Ta=25°C, Thermo Couple: Φ0.076mm

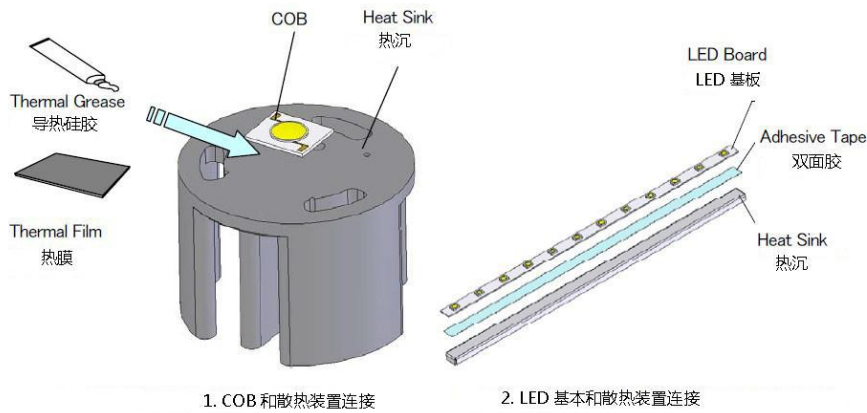

Figure 12 Connection schematic of the PCB and heat sink

Heat sink thermal radiation is a function of surface finish, especially when the heat sink is at higher temperatures. A painted surface will have a greater emissivity than a bright, unpainted one. The effect is most remarkable with flat-plate heat sinks, where about one-third of the heat is dissipated by radiation. The color of the paint used is relatively unimportant. The thermal resistance of a flat-plate heat sink painted gloss white will be only about 3% higher than that of the same heat sink painted matte black. With finned heat sinks, painting is less effective since heat radiated from most fins will fall on adjacent fins, but it is still worthwhile. Both anodizing and etching will decrease the thermal resistance.

A number of important factors need to be considered when selecting a heat sink:

- Surface area: Thermal transfer takes place at the surface of the heat sink. Therefore, heat sinks should be designed to have a large surface area. This goal can be reached by using a large number of fine fins or by increasing the size of the heat sink itself.

- **Aerodynamics:** Heat sinks must be designed in a way that air can flow through easily and quickly. Heat sinks with a large number of fine fins with short distances between the fins may not allow good air flow. A compromise between high surface area (many fins with small gaps between them) and good aerodynamics must be found.
- **Thermal transfer within the heat sink:** Large cooling fins are ineffective if the heat can't reach them. The heat sink must be designed to allow adequate thermal transfer from the heat source to the fins. Thicker fins have better thermal conductivity; so again, a compromise between large surface area (many thin fins) and good thermal transfer (thicker fins) must be found. The material used has a major influence on thermal transfer within the heat sink.
- **Flatness of the contact area:** The portion of the heat sink that is in contact with the LED or MCPCB must be perfectly flat. A flat contact area allows the use of a thinner layer of thermal compound, which will reduce the thermal resistance between the heat sink and LED source.
- **Mounting method:** For good thermal transfer, the pressure between the heat sink and the heat source must be high. Heat sink clips must be designed to provide high pressure, while still being reasonably easy to install. Heat-sink mountings with screws or springs are often better than regular clips. Thermo conductive glue or sticky tape should only be used in situations where mounting with clips or screws is not possible.

The formulas and diagrams given in this application note should be considered as a guide for thermal management of TDLEDs. The thermal resistance of a heat sink depends on numerous parameters that cannot be predetermined. These parameters include but are not limited to the position of the LED on the heat sink, the extent to which air can flow unhindered, the screening effect of nearby components, and heating from other components in the fixture. It is always advisable to check important temperatures in the finished fixture under the worst possible operating conditions and calculate the LED junction temperature. The probe points should be as close as possible to the back of the LED.

Data and/or information are subject to change without prior notice.